

ASSEMBLY INSTRUCTIONS







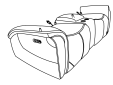

KAMARI COLLECTION

ITEM#: U092-25P2

DESCRIPTION : KAMARI CONSOLE LOVESEAT W/PWR
HR & FR-GRAY

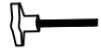
Thank you for purchasing this quality product. Be sure to check all packing materials carefully for small parts, which may have come loose during shipment. Identify and count all items and compare with the parts list shown below. It is recommended to have two people during assembling and to remove the back and base of the furniture out from the box.

Please follow the drawings below to assemble the item

Parts List			
NO.	DESCRIPTION	SKETCH	Q'TY
A	Seat		1 PC
B	Left Side Facing (LSF) backrest		1 PC
C	Console backrest		1 PC
D	Right Side Facing (RSF) backrest		1 PC
E	Knob Screw		2 PCS
F	Transformer		1 PC
G	Left Side Facing (LSF) Wing		1 PC
H	Right Side Facing (RSF) Wing		1 PC

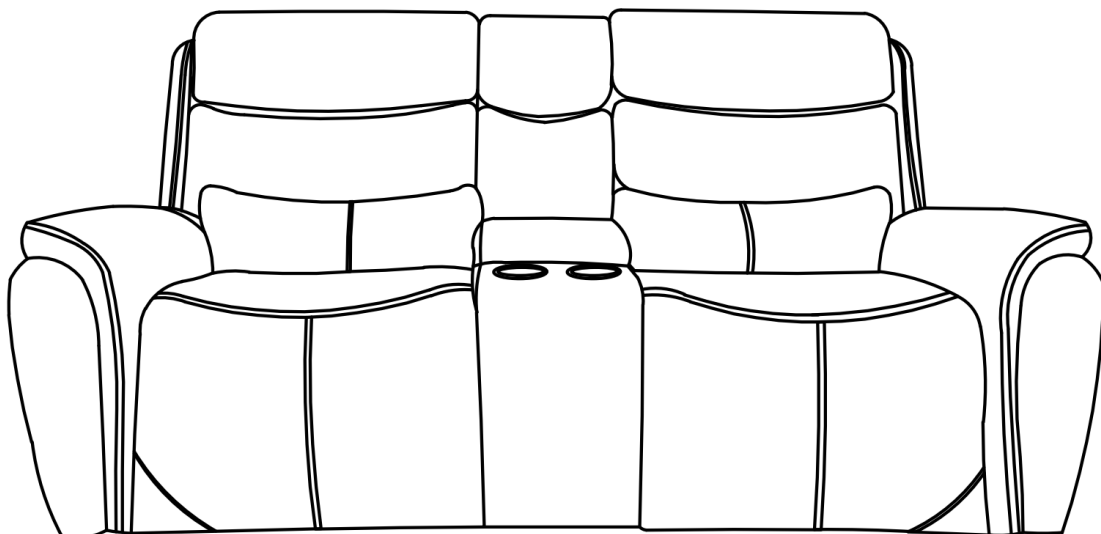

All images shown are for illustration purpose only.
Actual product may vary due to product enhancement.

ASSEMBLY INSTRUCTIONS

KAMARI COLLECTION

ITEM#: U092-25P2

DESCRIPTION : KAMARI CONSOLE LOVESEAT W/PWR HR & FR

Step 1:
Take the Console Backrest (C) out of the console base part of the seat (A). Attach the LSF and RSF backrests (B & D) to the seat (A) and connect the wire between the backrest (B & D) with wire on the Seat (A).

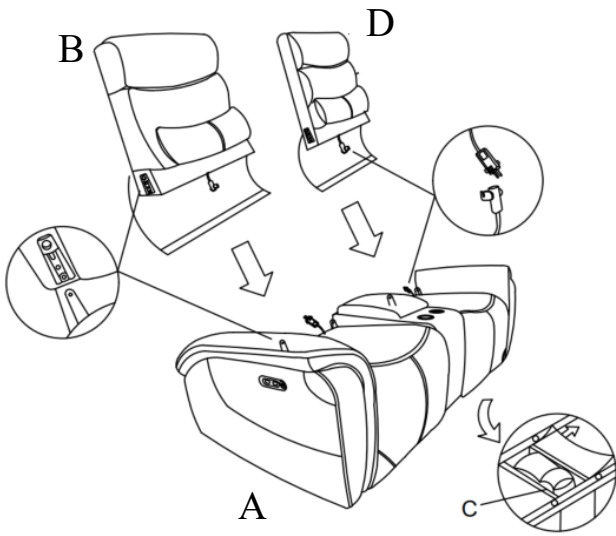

Console backrest

Step 2:
Attach the LSF Wing (G) to LSF Backrest (B) and RSF Wing (H) to RSF Backrest (D).

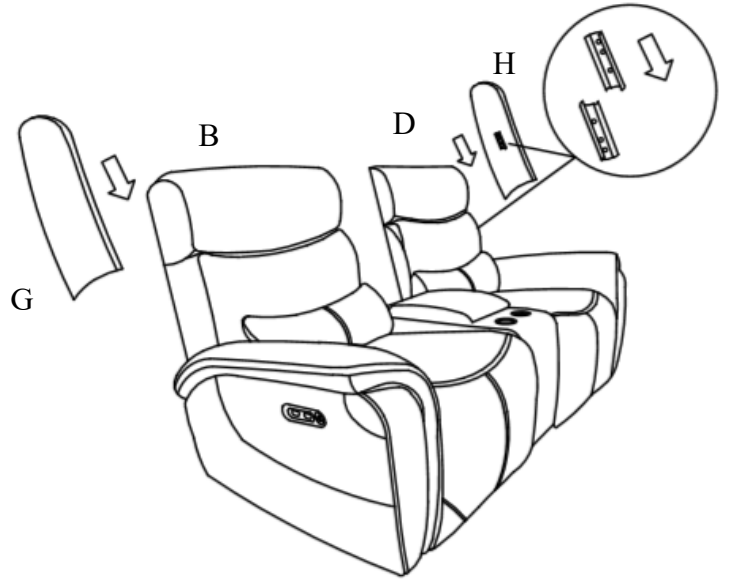

Step 3:
Place the console Backrest (C) in the right location and then attach to the seat (A) by turning the Knob Screws (E) counterclockwise. Locate the transformer at the bottom of the seat (A). Connect the transformer (F) to the power socket on seat (A).

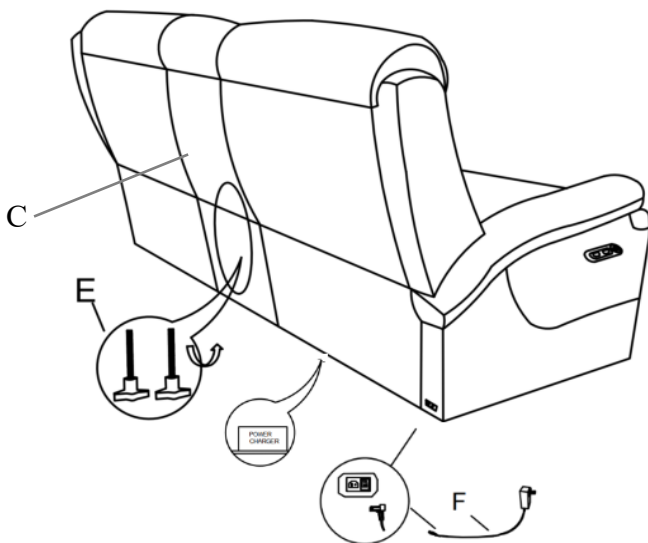

Step 4:
Open the footrest or move the headrest by pressing the power button.

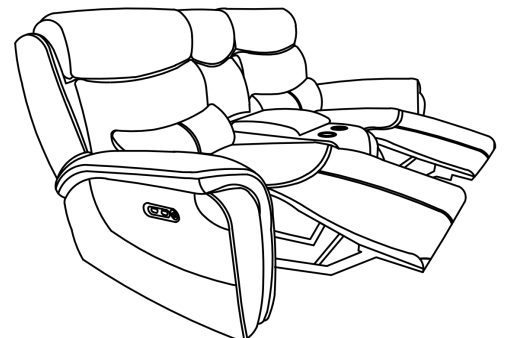
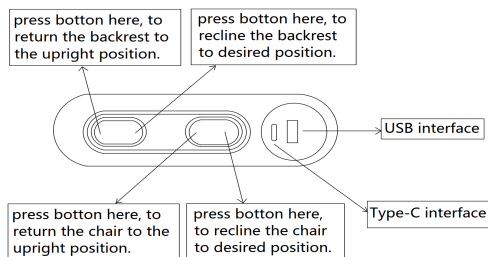

All images shown are for illustration purpose only.
Actual product may vary due to product enhancement.