





New
Classic
FURNITURE



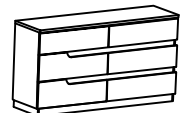
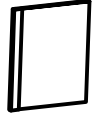

ASSEMBLY INSTRUCTIONS

B69-060 PARADOX MIRROR

PARADOX MIRROR

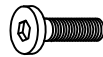
Thank you for purchasing this quality product. Be sure to check all packing materials carefully for small parts, which may have come loose inside the carton during shipment. Identify and count all items and compare with the parts list and/or hardware list shown below.

PARTS LIST			
ITEM	DESCRIPTION	SKETCH	QTY
1	DRESSER		1 PC
2	MIRROR		1 PC
3	MIRROR SUPPORT		2 PCS

HARDWARE LIST				
ITEM	DESCRIPTION	SKETCH	SIZE	QTY
A	JCBC SCREW		M6 x 1-3/8"	8 PCS
B	SPRING WASHER		M6 x 1/2"	8 PCS
C	FLAT WASHER		M6 x 3/4"	8 PCS
D	L - KEY		M4	1 PC

STEP 1

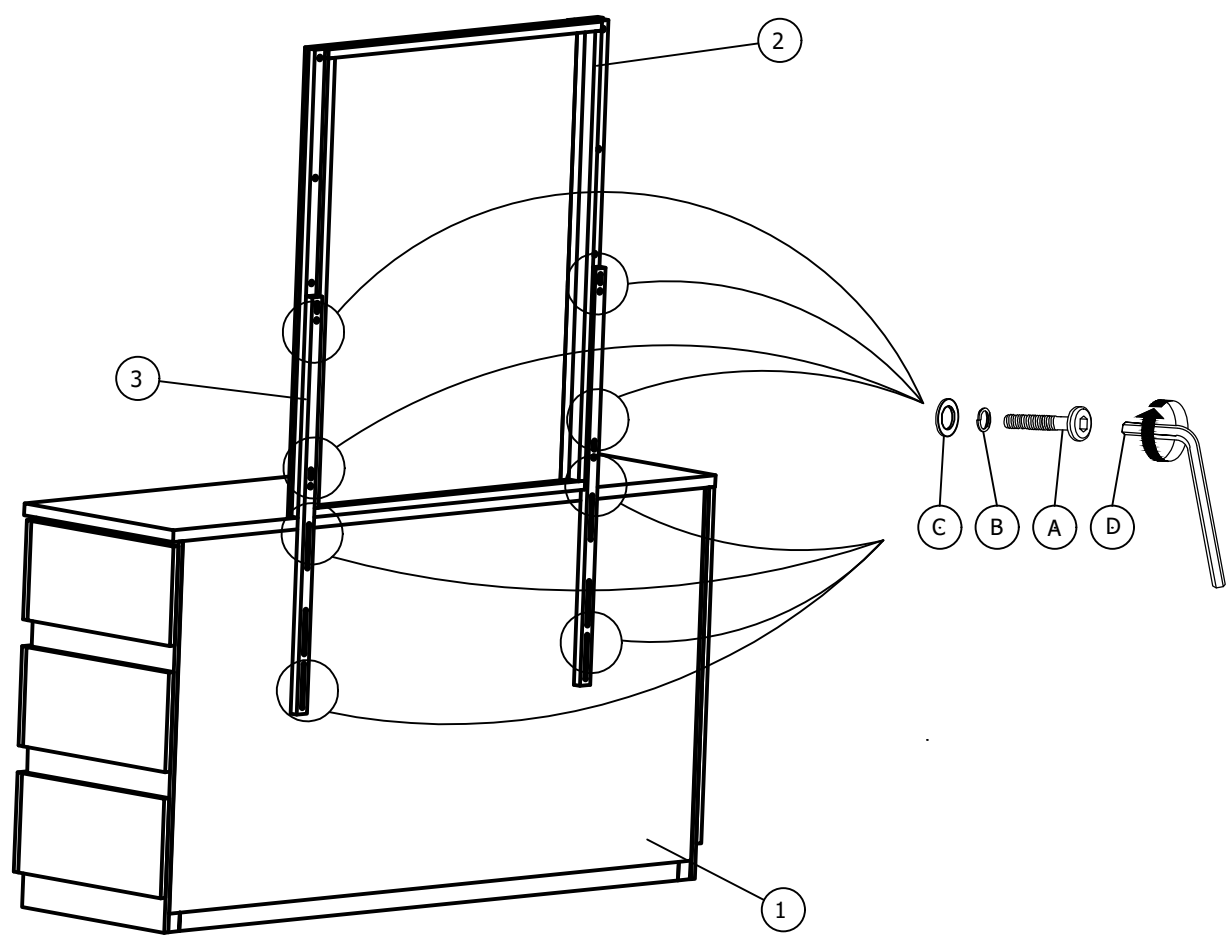

IMPORTANT NOTE :

- * Place all wooden parts on a clean and smooth surface such as a rug or carpet to avoid the parts from being scratched.
- * Check to be sure that you have all parts and hardware.
- * Remove all wrapping materials, including staples & packing straps before you start to assemble.
- * Do not tighten all screws/bolts until all completely assembled.
- * Keep all hardware parts out of reach of children.

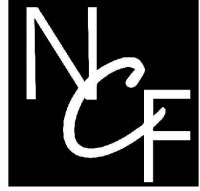

New
Classic[®]
FURNITURE

ASSEMBLY INSTRUCTIONS

B69-060 PARADOX MIRROR

PARADOX MIRROR

STEP 2

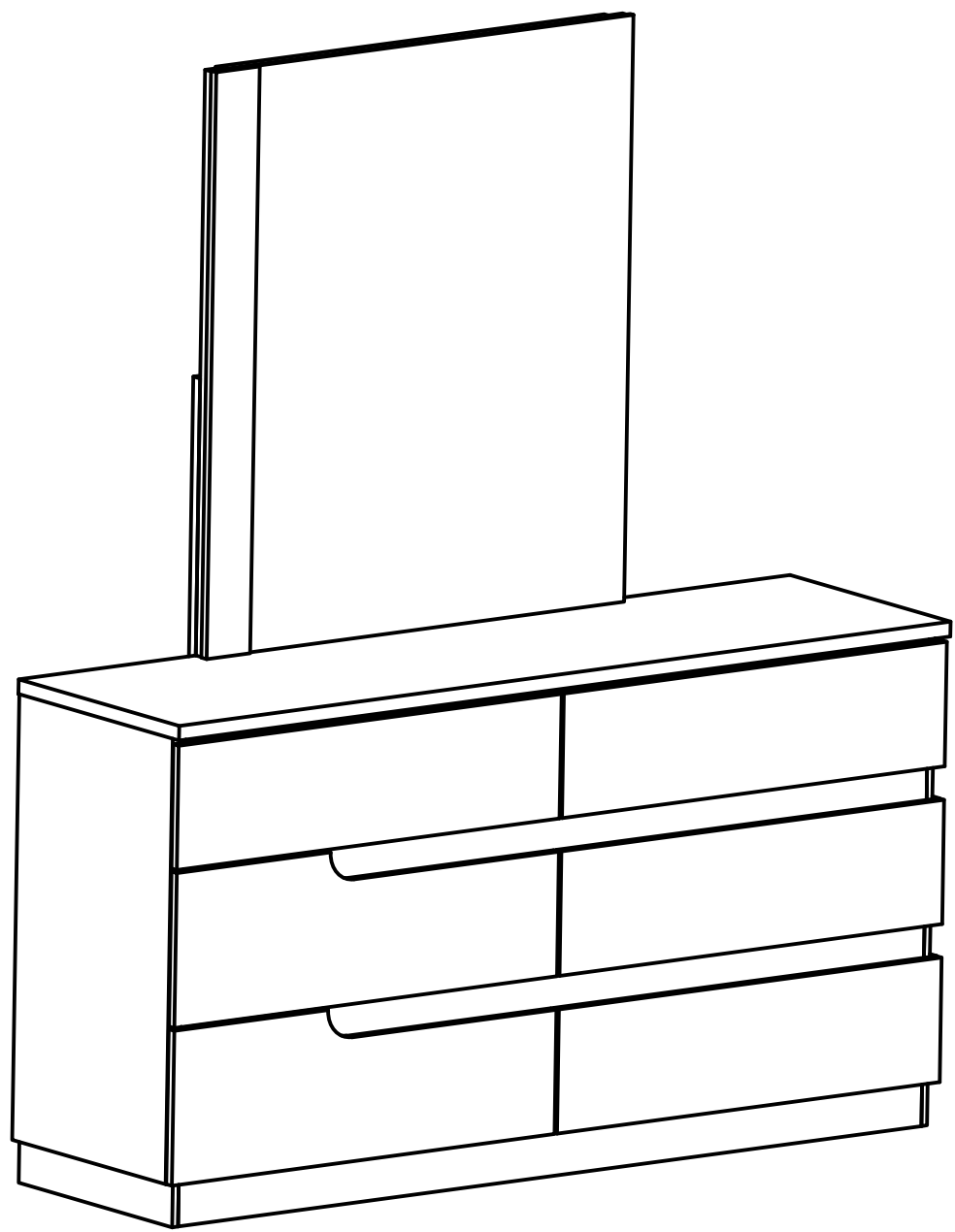

ASSEMBLY COMPLETED

IMPORTANT NOTE :

- * Place all wooden parts on a clean and smooth surface such as a rug or carpet to avoid the parts from being scratched.
- * Check to be sure that you have all parts and hardware.
- * Remove all wrapping materials, including staples & packing straps before you start to assemble.
- * Do not tighten all screws/bolts until all completely assembled.
- * Keep all hardware parts out of reach of children.