



Thank you for purchasing this quality product. Be sure to check all packing materials carefully for small parts, which may have come loose inside the carton during shipment. Identify and count all items and compare with the PARTS LIST and/or HARDWARE LIST shown below.





Caution: Please read the instructions thoroughly before assembly.

1. We recommend that you assemble this product with the assistance of another person: this will make the assembly easier, and will help eliminate damage to the product or injury to persons during assembly.
2. Please do not over tighten screws or bolts until the assembly is completed.
3. Please put all parts on a non-abrasive floor before assembly, and follow the assembly steps to assemble your newly purchased product correctly and efficiently

PARTS LIST

NO:	COMPONENT	SKETCH	Q'TY
A	DRESSER		1PC
B	MIRROR		1PC
C	SUPPORT		2PCS

HARDWARE LIST

NO:	COMPONENT	SKETCH	Q'TY
1	Bolt Ø1/4" x 1-1/2"		8pcs
2	Lock Washer Ø1/4"		8pcs
3	Flat Washer Ø1/4"x3/4"		8pcs
4	Allen key		1pc

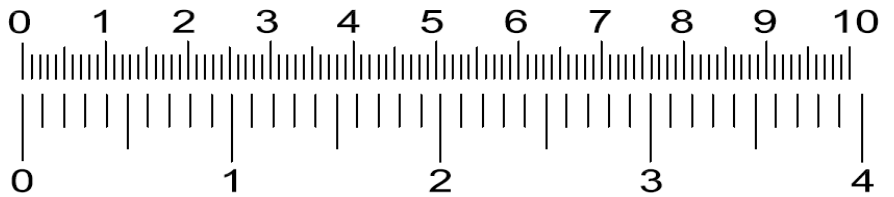

STEP 1

Assemble support (C) onto dresser (A) by using Allen Key (4) with hardware 1, 2, and 3.

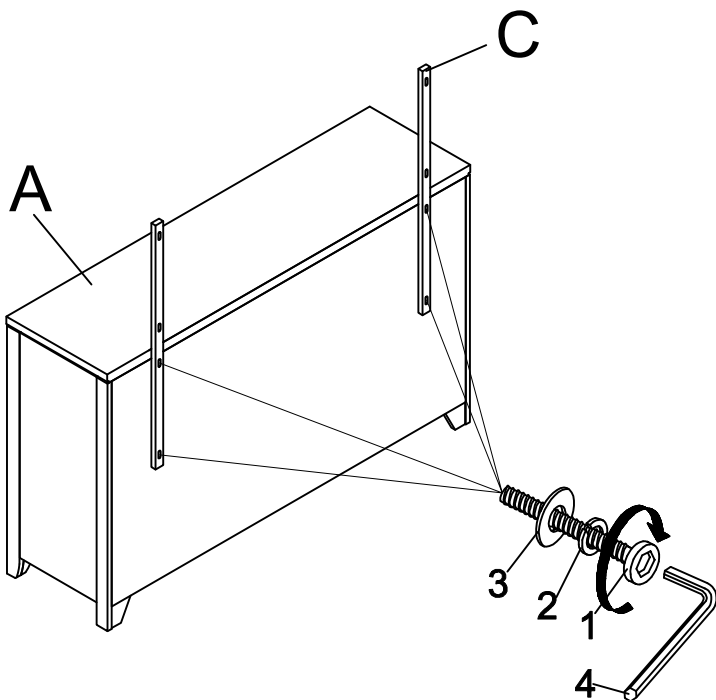

STEP 2

Assemble support (C) with mirror (B) by using Allen Key (4) with hardware 1, 2, and 3.

